

POWERFLEX®

PART NUMBER

PFR85-523

DESCRIPTION

REAR DIFF FRONT MOUNTING BUSH

INSTALLATION GUIDE

Contents (parts per pack):

- | | |
|-------------------------|----------------------------|
| 1 x Polyurethane A Bush | 1 x PTFE/Silicone Grease |
| 1 x Polyurethane B Bush | 1 x Stainless Steel Sleeve |
| 1 x Mild Steel Washer | |

Please read the complete fitting instructions and check package components before fitment. These fitting instructions are to be used as a guide and in conjunction with workshop manual.

It is recommended that:

- all work to be carried out by a licensed technician;
- all safety precautions adhered to;
- wheel alignment to be checked and adjusted as required after any suspension work.
- All fasteners must be tensioned to manufacturer's torque settings.



Fitting Instructions:

1. Remove the original rubber bush from the front position of the rear diff. Clean any dirt and corrosion from the bore of the diff and subframe mounting faces.
2. Fit the A part polyurethane bush into the bore in the diff in the lower position.
3. Fit the B part polyurethane bush into the bore into the diff in the upper position.
4. Apply some of the supplied grease to the bore of the bush and both mounting faces of the bush and insert the sleeve.
5. Raise the diff back into position, fit the supplied washer between the upper B bush and the subframe mounting face.
6. Fit the original domed washer into the lower A bush.
6. Re-tighten hardware to manufacturers recommended torque settings. Tension all hardware to manufacturers recommended torque settings.

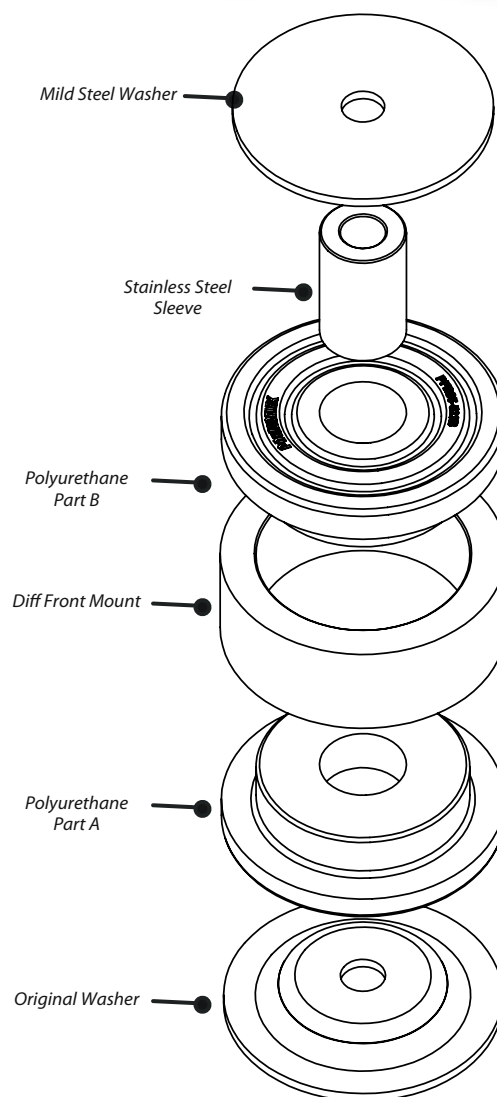

Figure 1